

M 650/2500
M 650/3000 (-)

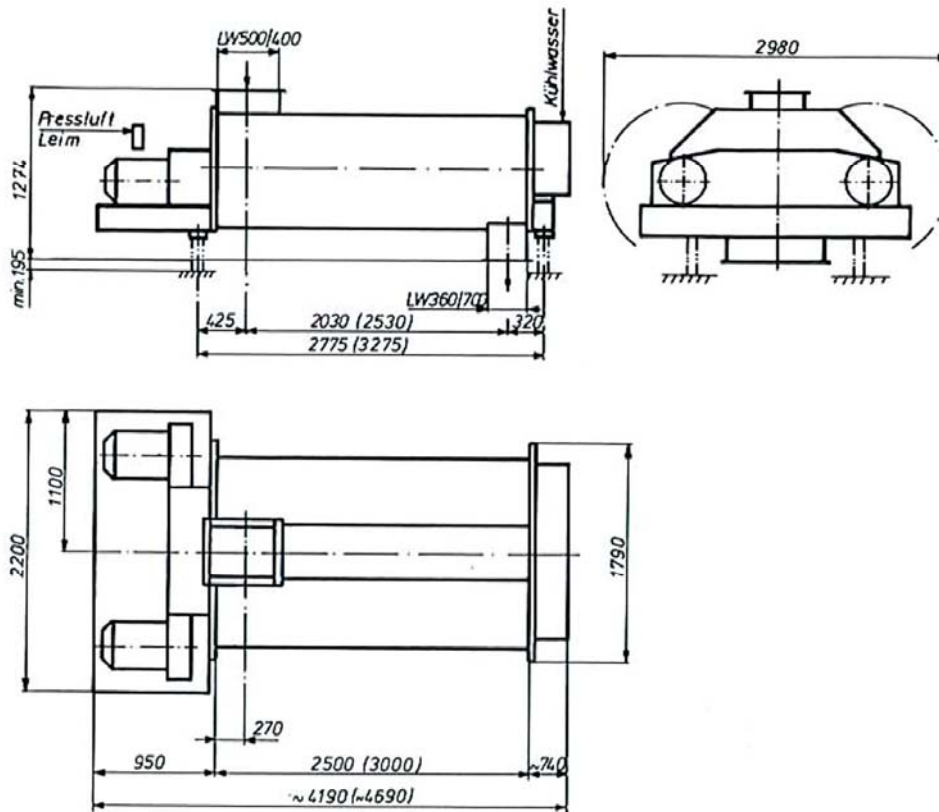

Technische Daten

Typ	Leistung at _{ro} /h Schüttgewicht ca. 130 kg/m ³	Massblatt	Motoren- Anschluss- leistung	Kühlwasser- menge bei 8°C	Pressluft- menge bei 3 bar	Mischwelle min ⁻¹	Schwenk- türen Antrieb	Gewicht mit El. Motoren
M 400/1750	1500–3200 kg	3-040-7-14617	2 × 11 kW 2 × 15 kW	2 m ³ /h	4,5 Nm ³ /h	900 min ⁻¹	2 × 0,37 kW	ca. 1720 kg
M 400/2000	2000–4000 kg	3-040-7-14984	2 × 15 kW 2 × 18,5 kW	3 m ³ /h	6 Nm ³ /h	900 min ⁻¹	2 × 0,37 kW	ca. 1900 kg
M 500/2000	2500–7000 kg	3-040-7-14613	2 × 18,5 kW 2 × 22 kW	4 m ³ /h	8 Nm ³ /h	800 min ⁻¹	2 × 0,37 kW	ca. 3100 kg
M 500/2500	3500–9000 kg	3-040-7-14612	2 × 22 kW 2 × 30 kW	6 m ³ /h	11 Nm ³ /h	800 min ⁻¹	2 × 0,37 kW	ca. 3500 kg
M 650/2500	5000–12800 kg	3-040-7-14608	2 × 30 kW 2 × 37 kW	9 m ³ /h	15 Nm ³ /h	650 min ⁻¹	2 × 0,55 kW	ca. 4120 kg
M 650/3000	7000–17000 kg	3-040-7-14611	2 × 37 kW 2 × 45 kW	12 m ³ /h	20 Nm ³ /h	650 min ⁻¹	2 × 0,55 kW	ca. 4500 kg
M 820/3000	10000–24000 kg	3-040-7-14560	2 × 45 kW 2 × 55 kW	15 m ³ /h	28 Nm ³ /h	520 min ⁻¹	2 × 0,55 kW	ca. 6000 kg
M 820/3600	14000–32000 kg	3-040-7-14563	2 × 75 kW	20 m ³ /h	45 Nm ³ /h	520 min ⁻¹	2 × 0,55 kW	ca. 6800 kg

Bemerkungen: Temperaturzunahme des Kühlwassers $\Delta t = 4^\circ$ bis 5°C je nach Maschinenauslastung